

KENWOOD

CD AUTOCHANGER / CONTROLLER /
FM MODULATOR SYSTEM

KDC-C602FM

INSTRUCTION MANUAL

KENWOOD CORPORATION



Take the time to read through this instruction manual. Familiarity with installation and operation procedures will help you obtain the best performance from your new CD autochanger / Controller / FM modulator system.

For your records

Record the serial number, found on the back of the unit, in the spaces designated on the warranty card, and in the space provided below. Refer to the model and serial numbers whenever you call upon your KENWOOD dealer for information or service on the product.

Model KDC-C602FM Serial number _____

Contents

Before use

Warning	3
Safety precautions	4
Handling compact discs	5
Features	6

CD auto-changer control features

CD play with CD auto-changer	7
Track / Disc search	8
Track repeat	9
Track scan	10
Random play	11
Loading compact discs	12

Installation

Accessories	14
Installation procedure	15
Before installation	16
Connections	18
Installation	19

Troubleshooting guide.....22

Specifications24

Warning

CAUTION

The use of optical instruments with this product will increase eye hazard.

INFORMATION

This equipment generates and uses radio frequency energy and if not installed and used properly, that is, in strict accordance with the manufacturer's instructions, may cause interference to radio and television reception. It has been type tested and found to comply with the limits for a Class B computing device in accordance with the specifications in Subpart J of Part 15 of FCC Rules, which are designed to provide reasonable protection against such interference in a residential installation. However, there is no guarantee that interference will not occur in a particular installation. If this equipment does cause interference to radio or television reception, which can be determined by turning the equipment off and on, the user is encouraged to try to correct the interference by one or more of the following measures:

- Reorient the receiving antenna
- Relocate this equipment with respect to the receiver
- Move this equipment away from the receiver
- Plug this equipment into a different outlet so that equipment and receiver are on different branch circuits.

If necessary, the user should consult the dealer or an experienced radio/television technician for additional suggestions. The user may find the following booklet prepared by the Federal Communications Commission helpful:

"How to Identify and Resolve Radio-TV Interference Problems".

This booklet is available from the U.S. Government Printing Office, Washington, DC 20402, Stock No. 004-000-00345-4.

- AS the laser beam used in this compact disc player is harmful to the eyes, do not attempt to disassemble the cabinet. Refer servicing to qualified personnel only.

FCC WARNING

This equipment may generate or use radio frequency energy. Changes or modifications to this equipment may cause harmful interference unless the modifications are expressly approved in the instruction manual. The user could lose the authority to operate this equipment if an unauthorized change or modification is made.

NOTE

This equipment has been tested and found to comply with the limits for a Class B digital device, pursuant to Part 15 of the FCC Rules. These limits are designed to provide reasonable protection against harmful interference in a residential installation. This equipment may cause harmful interference to radio communications, if it is not installed and used in accordance with the instructions. However, there is no guarantee that interference will not occur in a particular installation. If this equipment does cause harmful interference to radio or television reception, which can be determined by turning the equipment off and on, the user is encouraged to try to correct the interference by one or more of the following measures:

- Reorient or relocate the receiving antenna.
- Increase the separation between the equipment and receiver.
- Connect the equipment into an outlet on a circuit different from that to which the receiver is connected.
- Consult the dealer or an experienced radio/TV technician for help.

Safety precautions

Before use

▲WARNING

Take the following precautions to prevent fire and avoid personal injury :

- When extending the power supply cable, memory backup cable, or ground cable, use 0.75mm² (AWG18) or larger automotive grade cable to avoid cable deterioration or damage to the covering.
- Check that no metal objects (coins, tools, etc.) are left inside the unit to avoid short circuits.
- If you smell or see smoke, turn the power off immediately and consult your Kenwood dealer.

▲CAUTION

Take the following precautions to keep the unit in proper working order.

- Be sure the unit is connected to a 12V DC power supply with a negative ground connection.
- Do not open the top or bottom cover.
- Do not install the unit in places it is exposed to direct sunlight, high heat or humidity, water may splash over it, or dust exists.

NOTE

- If you have difficulty in installing this unit in your vehicle, contact your Kenwood dealer.
- If it doesn't seem to be working properly, first press the Reset button. If the malfunction persists, consult your Kenwood dealer.

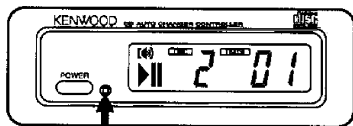

Reset button

- Some car stereos cause the sound of the tuner to make for a moment when an engine is activated.
- The reception of the tuner may be reduced a little if the KDC-C602FM is used.
- If the sound is lower than the tuner sound, raise up the volume level of the CD with using the receiver.

Cleaning the unit

- If the front panel is dirty, wipe it clean with a silicon cloth or soft dry cloth with the power off.

▲CAUTION

Do not use hard cloths or paint thinner, alcohol, or other volatile solvents. These may damage external surfaces or remove indicator characters.

Lens fogging

- In cold climates, there may be a period after you turn on your vehicle's heater when the lens that guides the laser beam used in your CD player fogs up. If this happens, you cannot play compact discs. Take out discs and the fogging will disappear. If it does not return to normal after several hours, contact your Kenwood dealer.

Heat protection

- In warm climates, when vehicles are left standing in direct sunlight with the windows closed, the temperature inside can rise above 60°C. The unit's protection circuits will then display the message "E 0d" and prevent the player from operating. Just open the windows or turn on the air conditioning. As soon as the "E 0d" message disappears, the player will operate normally.

Handling compact discs

Before use

Stains, scratches, or warping can cause skipping, malfunction, or low sound quality. Take the following precautions to avoid damage to the compact discs.

Holding a disc

- Avoid touching the recorded side (the side without the titles on) when you hold a compact disc.



- Do not stick paper tape, etc. on either stick of the disc.

Paper tape



Storing your discs

- Do not store discs where they will be exposed to direct sunlight (such as on the seat and dashboard) or high heat.
- If you do not use your unit for an extended time, remove the discs from the unit and put them in their cases. Do not leave them lying around without cases, piled up, or leaning on a wall and so on.

Cleaning your discs

- If there are stains on a disc, wipe them off with a cleaning cloth or a soft cotton cloth, wiping from the center to the edge. Never use conventional record cleaners, anti static agent, paint thinner, benzene, or other chemicals.

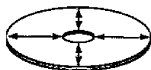

Check your new discs

- Some new discs have burrs on their outer edges or around the hole in the center. Discs with burrs may not fit properly on the player, causing skipping when they are played. Use a ballpoint pen or similar instrument to remove the burrs.

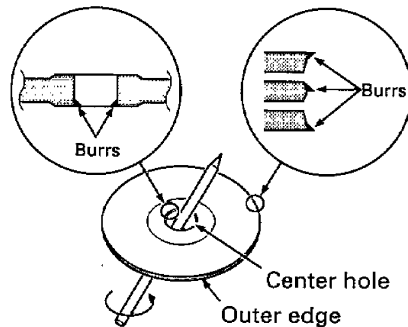

Disc accessories

- Stabilizers, protective seals, and other disc accessories on the market, which claim to offer improved sound quality or disc protection, may cause this unit to malfunction. They should not be used on discs played in this unit.

CAUTION

Never use 8 cm (3") compact discs

- If you attach an adapter to an 8 cm (3") compact disc and load it into this unit, the adapter may be detached from the disc, causing damage to the unit. Do not use 8 cm (3") compact discs.

Features

Before use

- **Frequency modulation system**
Even if your car audio(car stereo) is not equipped with an AUX input jack, you can use the radio's builtin FM tuner to listen to music played by the CD autochanger using FM broadcast frequencies.
- **CD auto-changer control (Page 7)**
This unit has a CD auto-changer control function.
- **Track / Disc search (Page 8)**
You can search for the track / disc you want by specifying the track / disc number.
- **Track repeat (Page 9)**
When this function is turned on, the track you are listening to is played repeatedly.
- **Track scan (Page 10)**
When this function is turned on, the first part of each track on the disc you are listening to is played automatically to help you find the one you want.
- **Random play (Page 11)**
When this function is turned on, the tracks on the disc you are listening to are played in random order.

CD play with CD auto-changer

Set the car-radio in FM tuner mode and receive a modulated frequency (88.3 MHz or 88.7 MHz) which is set by the RF modulator (page 16).

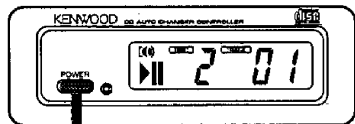

Power button

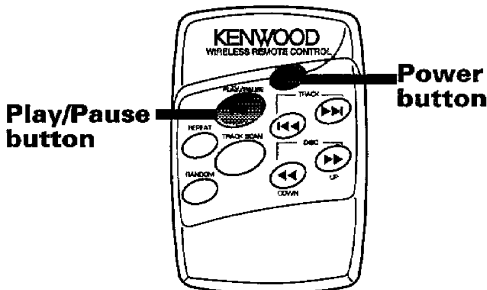

CD-auto changer control features

To play compact discs

Press the Power button.
The power goes ON and the CD play start. The light turns on for an instant every time the controller switch is pressed.

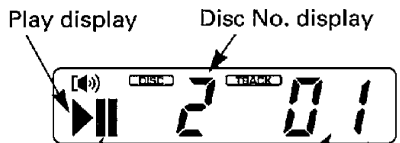

Pause display

When the player reaches the end of the last track on the disc you are playing, it will shift automatically to the first track on the next disc. When the player plays the last disc, it will return to the first disc.
Disc No. 10 is displayed as "0".

Power off

Press the Power button.
The power goes OFF.

To listen to the radio

Press the Power button on the controller.
(The RF modulator is turned OFF and the radio can be heard.)

Pause

Press the Play/Pause button.
Disc play is temporarily paused.
If you press the switch once more, the disc is replayed from the paused part.

NOTE

- Be sure to turn down the volume whenever you listen to the radio or a cassette tape after stopping the disc play.
- During the disc play is being conducted, you are not able to receive ordinary Radio broadcasting because antenna output is switched into compact disc player's side.

Track/Disc search

CD-auto changer control features

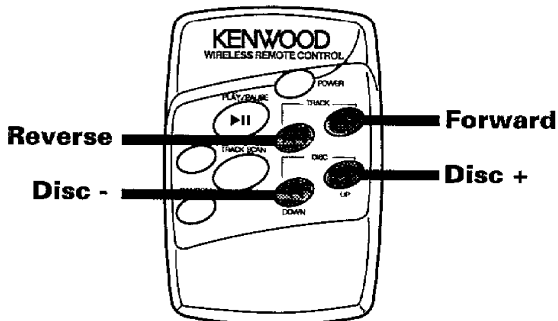

Reverse track search

Briefly press the Reverse button. When you press this button once, the player returns to the start of the track you are listening to. Each time you press the button, the track number on the display decreases. The player plays the track with the track number shown on the display.



Track No.

NOTE

If you try reverse track search while playing track 1, the player will resume play at the start of track 1; it does not search for the last track.

NOTE

If you try forward track search while playing the last track on a disc, the Forward track search function does not work.

Reverse disc search

Press the Disc - button. Each time you press this button, the disc number on the display decreases. The player plays the disc with the disc number shown on the display.

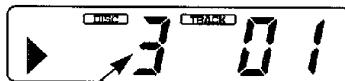

Disc No.

Forward track search

Briefly press the Forward button. Each time you press this button, the track number on the display increases. The player plays the track with the track number shown on the display.



Track No.

Forward disc search

Press the Disc + button. Each time you press this button, the disc number on the display increases. The player plays the disc with the disc number shown on the display.



Disc No.

Track repeat

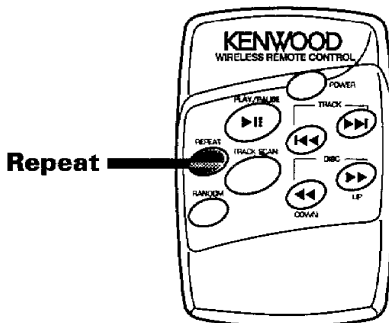

To repeat track

Press the Repeat button.
The Repeat indicator will appear on the display and the Track repeat function will turn on.
The same track is played repeatedly.



ON

To cancel

Press the Repeat button.
The Repeat indicator disappears and the Track repeat function is cancelled.

Track scan

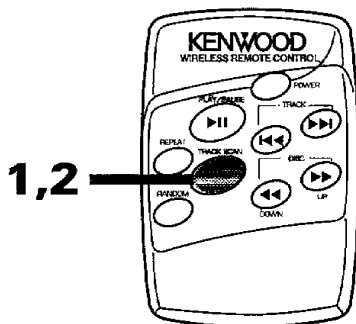

1

Press the Track scan button. The player will play the first 10 seconds of each track in succession. The track number blinks on the display.

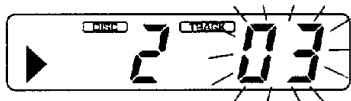

2

To select a track
Press the Track scan button. The Track scan is cancelled and normal playback starts.

NOTE

- When CD play stops, Track scan is cancelled.
- When all tracks on the disc you are listening to are scanned, Track scan is cancelled.

Random play

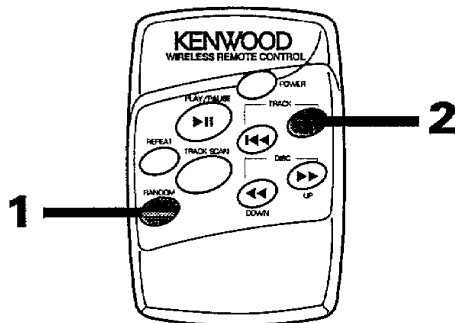

CD-auto changer control features

1

Press the Random button. The Random indicator will appear on the display and the player will randomly select another track from the disc you are playing. The track numbers on the display will change continuously during track selection. When a track is selected, playback will begin automatically.

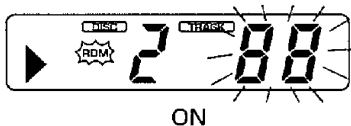

NOTE

When all the tracks on a disc have been played, the player will randomly select the next disc.

2

To select another track
Press the ►| button.
The player will randomly choose another track.

To cancel

Press the Random button. The Random indicator disappears and Random play is cancelled. Normal CD play starts.

NOTE

When the CD play stops, the Random play function is cancelled.

Loading compact discs

1

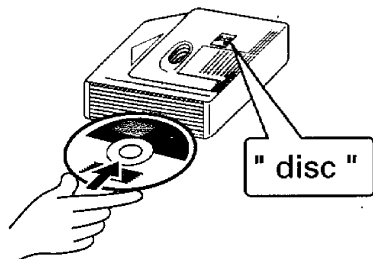

- Load the disc with its label surface facing upwards.
Only one CD can be inserted in a slot.
Up to 10 CDs can be loaded in a magazine.
Disc numbers are indicated as 1, 2, 3, ... from the bottom with the magazine "disc" mark facing upwards.

CAUTION

8-cm discs cannot be used. If an 8-cm disc adapter is used, the disc cannot be ejected.

2

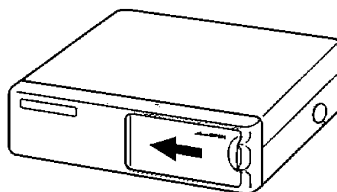

- Open the CD changer door.

3

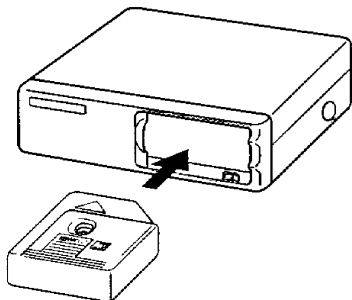

- Insert the magazine into the CD changer until it clicks.

4

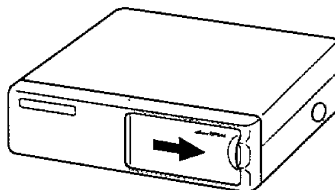

- Close the CD changer door.

CAUTION

Use the CD changer with its door closed to prevent the entry of dust into the changer.

5 Magazine ejection

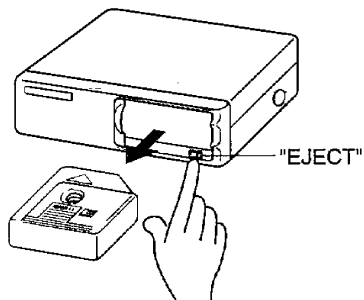

- Open the CD changer door, and press the "EJECT" button.

NOTE

Be sure to open the door completely before pressing the EJECT button. If the door is not completely open, the magazine may hit the door and cause damage or malfunction.

6 Disc ejection

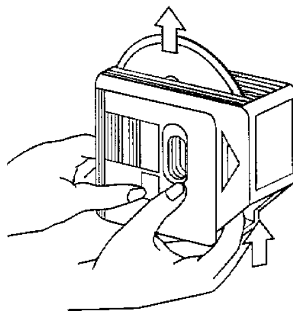







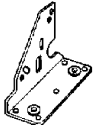
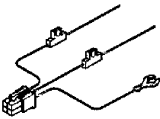
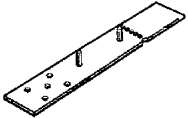

- Push the disc.

CAUTION

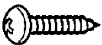
If you push the disc too hard, it will fly out.

Accessories

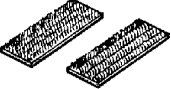
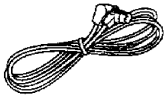
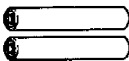
Installation

Part name	External view	Number of items	Part name	External view	Number of items
Bracket		2	Wiring harness		1
Plate		2	Metal fixture		2
Self-tapping screw ($\phi 5 \times 20$)		4	Self-tapping screw ($\phi 4 \times 12$)		2
Assembly screw with washer (M5 \times 12)		4	Bind head screw ($\phi 3 \times 6$)		4
Hex nut (M5)		4	Velcro (for display/remote control unit)		Units for Each two
Changer connection cable (5 m)		1	Battery ("AAA" UM-4) (for remote control unit)		2
Tape		2			

Installation procedure

1. Remove the ignition key and disconnect the negative (-) terminal of the battery to prevent short circuits.
2. Connect the input and output cables of the units.
3. Connect the ground cable, memory backup cable, and power supply cable of the wiring harness in the order listed.
4. Connect the wiring harness connectors to the unit.
5. Install the unit in the car.
6. Connect the negative (-) terminal of the battery.
7. Press the Reset button.

⚠ CAUTION

- If you need to replace the fuse, make sure the new fuse is of the same type and rating. Using a fuse of a different type of rating may damage your unit. The fuse rating is normally shown on the fuse and fuse box.
- Check that no unconnected cables or connectors are touching the car body.
- After installation, check that the brake lamps, wipers, and wipers work properly.
- When making the hole, make sure not to damage the fuel tank, brake tube, wiring harness, etc. on the other side.
- If the CD autochanger is installed near speakers, the speakers vibration causes a sound skip. Be sure not to do that.
- Do not install the unit at a dusty place. If the unit is installed at a dusty place, dust accumulates inside the unit and unit may be damaged.

Attaching the dust cover

Before installing the CD auto changer, attach the dust cover on the rear of the main unit.

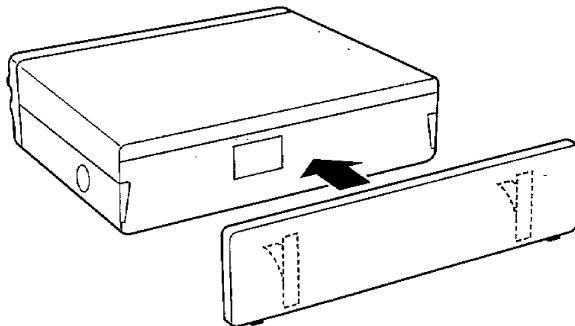

Before installation

Installation

Use the operation panel of RF modulator unit

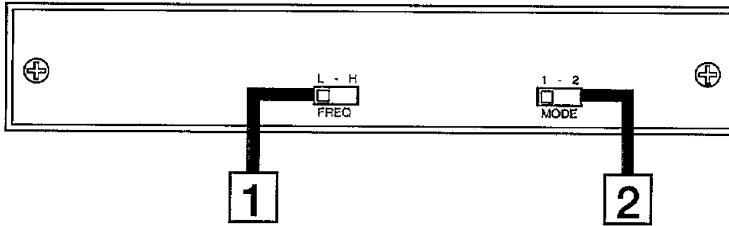

1 HOW TO SET MODULATION FREQUENCY

- Set this modulation frequency into either "L" or "H", either of which causes less radio interference (noises) than other because FM signals are modulated to 88.3 MHz and 88.7 MHz if "L" and "H" is set respectively. The reception frequency of the radio is also changed to the one specified with this switch.

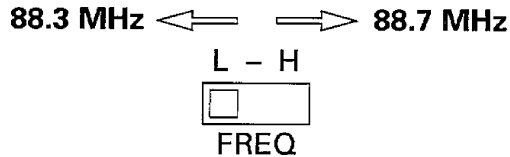

2 HOW TO SET THE MODE SWITCH

- Select either mode position to meet your system's volume; if Position 1 gives rise to noise, use Position 2

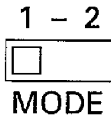

Position of MODE switch	Volume
1	Normal
2	Low

NOTE

- Playing a disc with a high record level may introduce noise; use Position 2 toward off the noise out of this type of disc.

Angle adjustment switches

The angle adjustment switches on the bottom panel are to be set according to the angle of installation of the CD auto changer. Set both of the two switches to the same position. If the switches are not set properly, sound skip or other malfunction may occur.

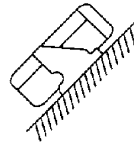
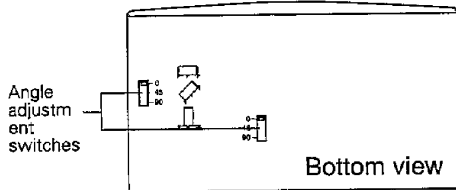

- It is not possible to install at an angle of 40°~50° deg. if only bracket is used.

	0°~5°	40°~50°	85°~90°
Installation angle			
Angle adjustment switch position			

Loading/replacing batteries

- The control unit uses two "AAA"-size (UM-4) batteries. The battery life is approximately one year. When the life has expired, please replace both of them with new batteries.

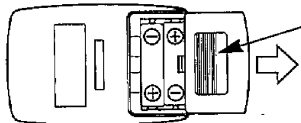

Push and hold here, and slide the lid in the direction of the arrow.

- Insert batteries following the illustration inside the battery box, taking care not to reverse the ⊕ and ⊖ polarity.

▲ CAUTION

- The provided batteries are not rechargeable.

Note regarding to the use of Batteries

If a battery is used improperly, liquid leakage or brokerage of the battery may be brought about. Obey the following actions:

- Put the battery into the battery compartment while keeping its pole correctly.
- If the battery-liquid leakage takes place, wipe the battery liquid left in the compartment well with soft and dry cloth then replace the battery with new one.
- Do not short-circuit the metal built in the battery compartment while a battery is being placed there.
- Do not use different kind of battery and second-hand battery together.
- Do not throw the battery into flame.

Connections

Installation

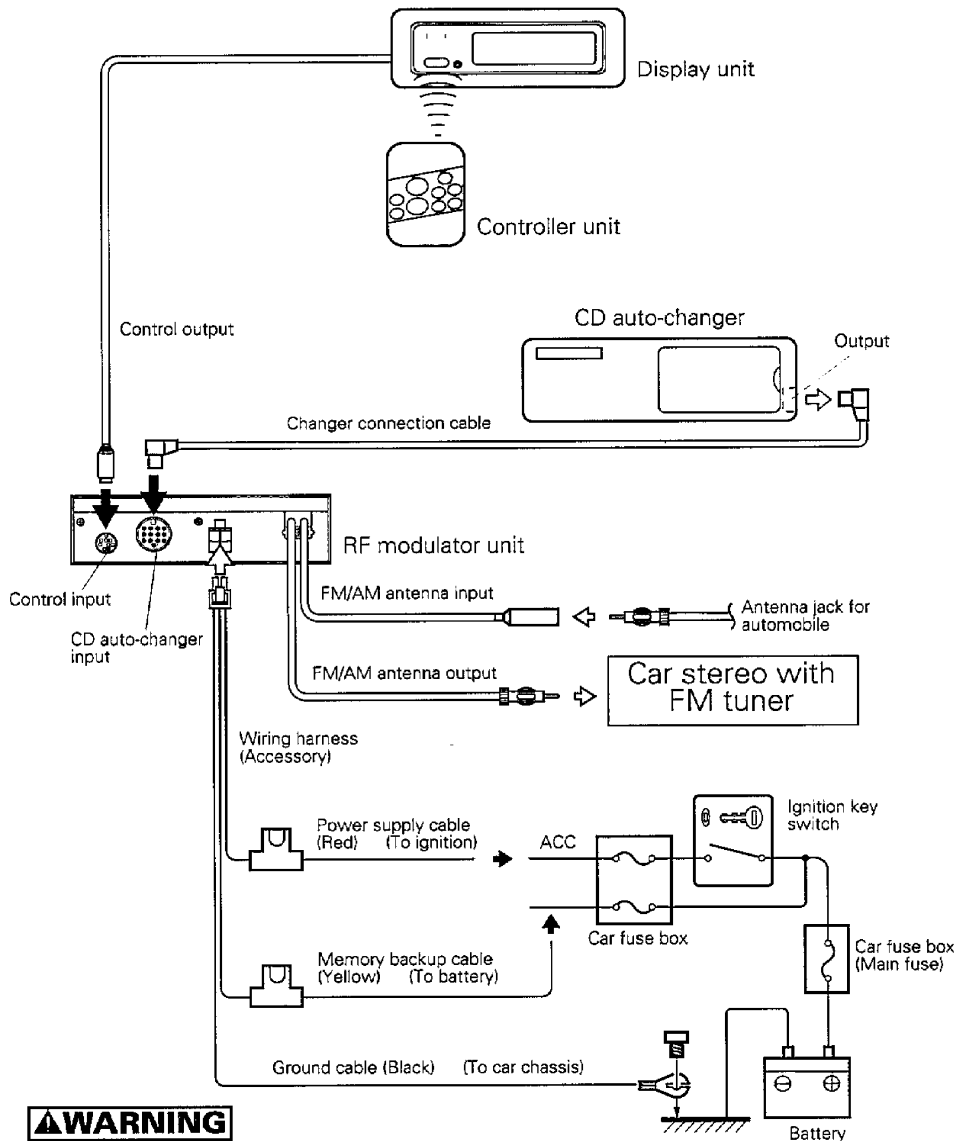

⚠ WARNING

To prevent fire when the power supply cable (Red) or memory backup cable (Yellow) is short-circuited by coming into contact with the vehicle chassis (ground), only connect the power supply after making the fuse box connections.

Installation

Installation of Controller unit and Display unit

Installation

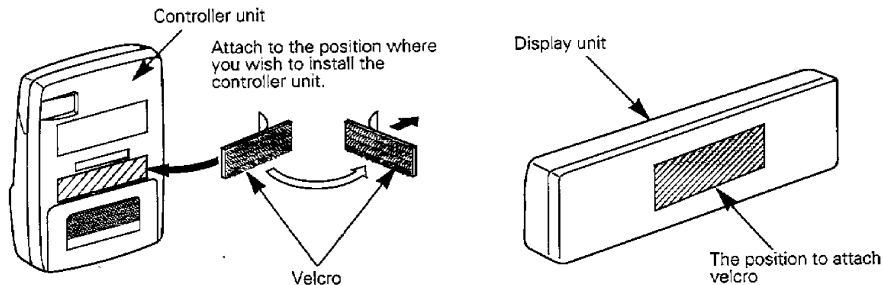

Attach one velcro to the slanted-line of the controller and the display units as shown above, and attach the other velcro to the parts where you wish to attach the controller and display units.

Then, put velcros together and install the controller and display units.

CAUTION

- Be sure not to place the unit on such place as where it is exposed to direct sunlight and temperature eventually rises.
It results in the deformation of the case, breakage of batteries, leakage, of battery liquid and so on.
- Depending on the installing location, the display unit may not be able to receive the signals from the controller unit. Install them after confirming that the signals can be received.
- Install the unit in such a way that it does not disturb driving.

Installation of RF modulator unit

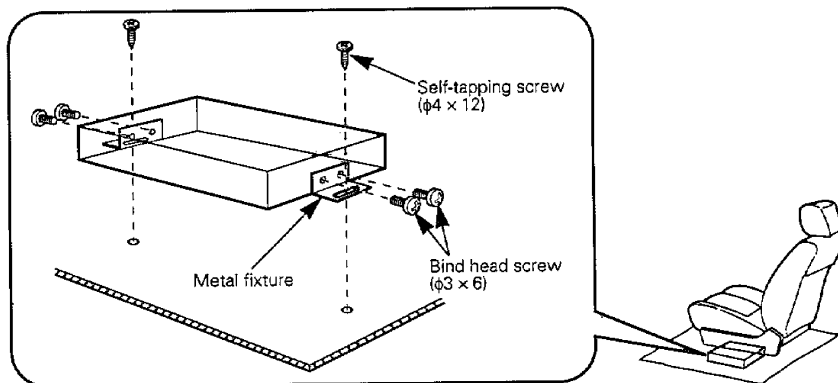

Install the RF modulator unit beneath the front seat using Metal fixture and Bind head screw as shown in the above figure.

Installation

* Attach the Brackets with the screws inserted in the blackened holes. (Do the same for the left side also.)

Installation

Horizontal installation

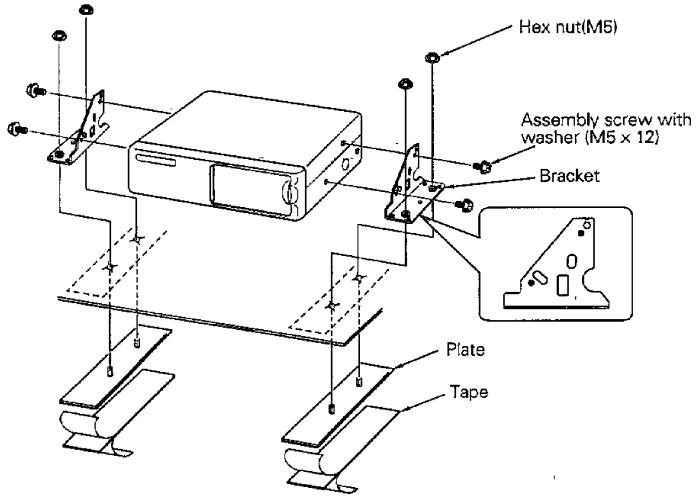

Vertical installation

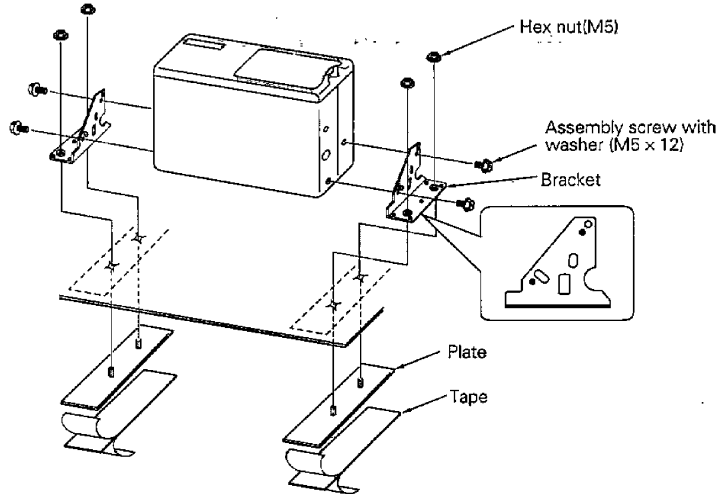

Horizontal installation

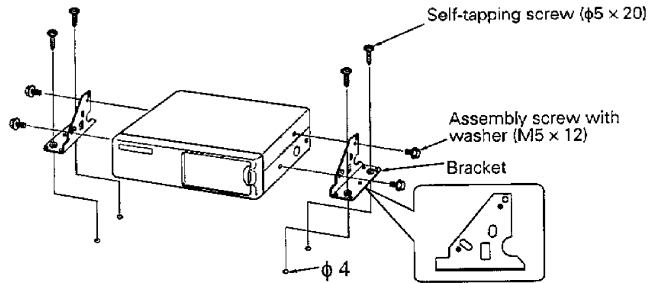

Vertical installation

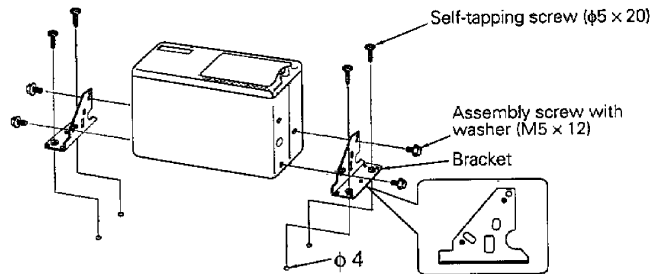

In case of hanging in the trunk

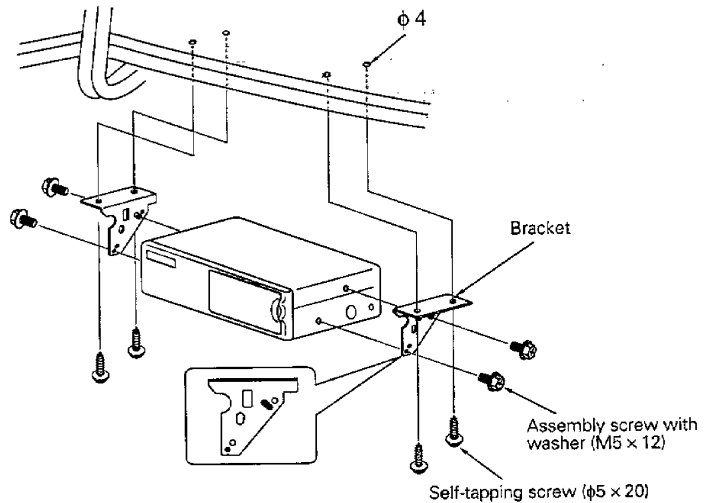

Troubleshooting guide

Troubleshooting guide

Often, what appears to be a malfunction is due to user error. Before calling for service please consult the following table.

Symptom	Cause	Remedy
The power is not turned on.	The wiring harness fuse blows.	Check cables for shorts, then replace the fuse with one of with the same rating (shown on the case).
No sound or sound is low.	The volume level is minimum.	Raise the volume level.
	The fader or balance is set to one side.	Adjust the fader and balance.
	The input/output cable or wiring harness is connected incorrectly.	Connect the input/output cable or wiring harness correctly. See "Connections" (Page 18).
The unit does not work properly when a button is pressed.	The microcomputer malfunctions.	Press the Reset button of the display unit.
Sound quality is poor. (Sound distortion)	The volume level is too high.	Use the appropriate volume level.
CD play does not start.	CD auto-changer input is not connected to the unit.	Connect the CD auto-changer input to the unit.
	Power button is not turned ON.	Turn the power button ON.
The specified disc is not played; a different disc is played instead.	The specified disc is very dirty.	Check and, if possible, clean the disc. See "Cleaning your discs" (Page 5).
	The disc is loaded upside down.	Eject the disc magazine and insert the disc correctly.
	Two discs are inserted in a slot.	Eject the disc magazine and insert the discs correctly.
	The number of the slot into which the disc is inserted is different from the number of the specified disc.	Eject the disc magazine and check the number of the specified disc.
	The disc is severely damaged.	Use another disc.
Sound skips due to vibration.	Something is touching the CD auto-changer.	Keep it away from the CD auto-changer.
	The disc is dirty or damaged.	If sound skips at the same part, the disc is faulty. Check and, if possible, clean the disc. See "Cleaning your discs" (Page 5).
	The unit is mounted at a slant.	Mount the unit so that is level.
	Changer unit is mounted in an unstable place.	Mount the unit in a stable place.
	The angle adjustment switches are set improperly.	Set the angle adjustment switches to the correct positions.

Symptom	Cause	Remedy
Sound quality is poor.	The recording of the disc is poor.	Try playing another disc. If the sound is good, the fault was with the original disc.
	The disc is dirty or damaged.	Check and, if possible, clean the disc. See "Cleaning your discs (Page 5)".
No sound is heard even though the information concerning the CD auto-changer is displayed.	Volume is set to minimum level.	Raise the volume level.
	The microcomputer does not function correctly.	Press the Reset button of the display unit.
	The system is not connected properly.	Connect the system properly. See "Connections" (Page 18).
The specified track is not played.	The player is set to RANDOM PLAY.	Turn off RANDOM PLAY.

In some cases, you may see one of the following error messages on your unit's display.

- E 01:** No disc magazine in changer. Disc magazine is not inserted properly.
⇒ Insert the disc magazine properly.
- E 02:** No disc in disc magazine.
⇒ Load a disc in the disc magazine.
- E 04:** Disc is too dirty. The disc is upside down. The disc is damaged.
⇒ Clean the disc and insert it correctly.
- E 09:** The unit malfunctions due to a defective CD mechanism.
Press the Reset button. If the "E 09" message does not disappear, contact your Kenwood dealer.
- E 0d:** When the temperature exceeds 60°C, a protection circuit will stop all operations. This message will then be displayed.
⇒ Let the place where the changer is located cool down. As soon as it has cooled, the changer starts playing.

Specifications

Specifications subject to change without notice.

Specifications

Disc Section

Laser Diode	GaAlAs ($\lambda=780$ nm)
Digital Filter (D/A)	8 Times Over Sampling
D/A Converter.....	1 bit
Spindle speed.....	500 ~ 200 rpm (CLV)
Wow & Flutter.....	Below Measurable Limit
Modulating Frequency (Hi)	88.7 MHz
(Lo)	88.3 MHz

Laser Diode Properties

Material	GaAlAs
Wavelength	780 nm
Emission Duration	Continuous
Laser Output Power.....	Less than 44.6 μ W

*This output is the value measured at a distance of 200 mm from the objective lens surface on the Optical Pick-up Block.

General

Operating Voltage.....	14.4 V (11 ~ 16 V)
Current consumption.....	1.4 A
Operating Temperature.....	-10 ~ 50 °C
Size (W x H x D)	
(CD auto changer).....	281 x 76 x 171 mm (11-1/16 x 3 x 6-3/4 in.)
(Controller).....	59 x 91 x 17 mm (2-5/16 x 3-9/16 x 6-11/16 in.)
(Display unit).....	95 x 35 x 19 mm (3-3/4 x 1-3/8 x 3/4 in.)
(RF modulator unit).....	150 x 30 x 120 mm (5-7/8 x 1-3/16 x 4-3/4 in.)
Weight	
(CD auto changer).....	3.0 kg (6.6 lbs)
(Controller).....	0.05 kg (0.1 lbs)
(Display unit).....	0.1 kg (0.2 lbs)
(RF modulator unit).....	0.8 kg (1.8 lbs)